



# Free Space Optical Communication

## Performance Investigation of 40 GB/s DWDM over Free Space Optical Communication System Using RZ Modulation Format

**Abstract**— We successfully demonstrate 40 GB/s 8 channels’ Dense Wavelength Division Multiplexing (DWDM) over free space optical (FSO) communication system. Each channel is transmitting 5 GB/s data rate in downstream separated by 0.8nm (100GHz) channel spacing with 1.8GHz filter bandwidth. DWDM over FSO communication system is very effective in providing high data rate transmission with very low bit error rate (BER). The maximum reach of designed system is 4000m without any compensation scheme. The simulation work reports minimum BER for Return-to-Zero (RZ) modulation format at different channels 1, 4, and 8 are found to be  $2.32e-17$ ,  $1.70e-16$ , and  $9.51e-15$  at 4000m distance, respectively. Sharp increase in BER occurs if data rate and distance increase up to 10 GB/s and 5000 m [1].

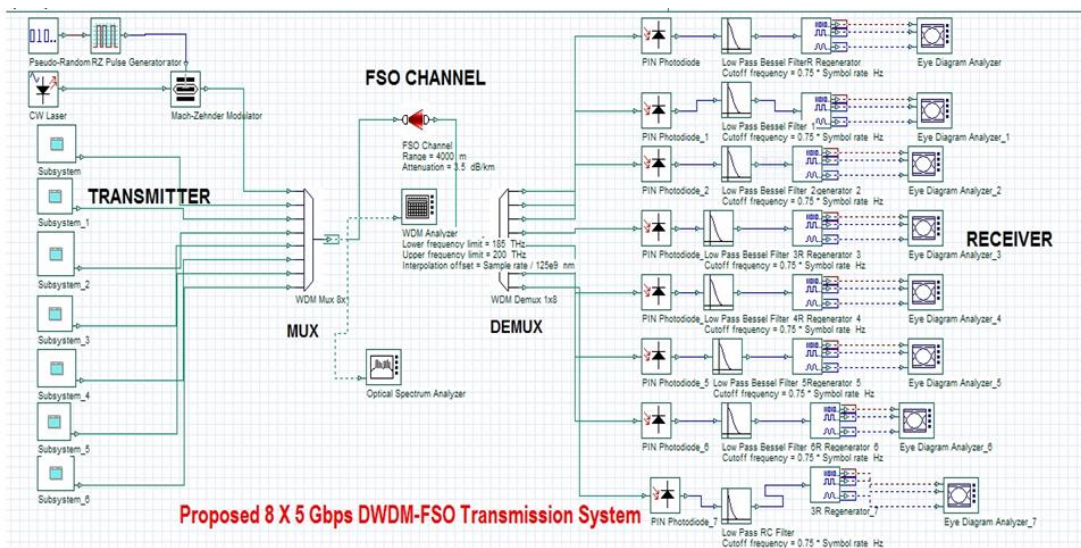

Figure 1: Proposed 8 X 5Gbps DWDM-FSO Transmission System by using OptiSystem software.

### Project Layout

The proposed 8 x 5 Gbps free space optical communication system as shown in Figure1 is modelled by using OptiSystem software. Dense wavelength division multiplexing with channel spacing of 0.8 nm is adopted to transmit 40 Gbps of data over 4 km of free space link. At the transmitter side, 8 channels, each carrying 5 Gbps return to zero (RZ) data, are multiplexed together and transmitted directly over free space link without using any compensation technique. The peak power of laser is set to 30 mW for each channel. Figure 2 represents optical spectrum measured at output of transmitter. At the receiver side, each channel is demodulated by PIN photodiodes followed by low pass Bessel filters with cut-off frequency of 1.8 GHz. The performance of the proposed high speed FSO system is measured in terms of bit error rate (BER) and quality factor (Q).



## Results

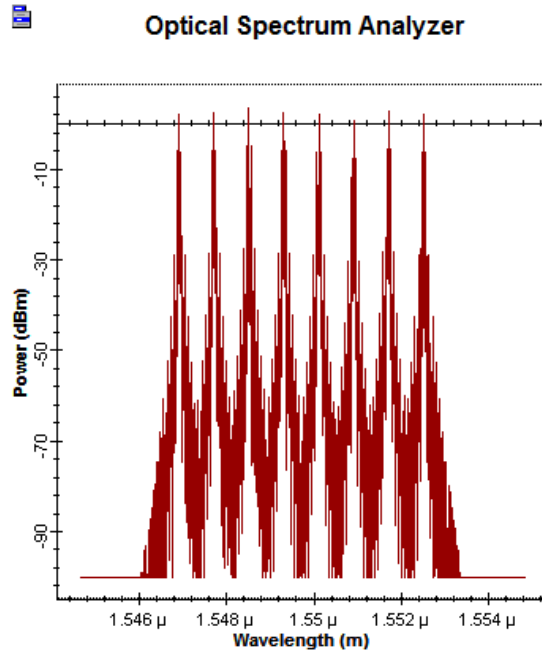

Figure 1: Optical Spectrum at Transmitter side.

Figure 3(a) and 3 (b) represents the measured bit error rate and quality factor with respect to free space link range. The BER of each channel increases as the FSO range increases.

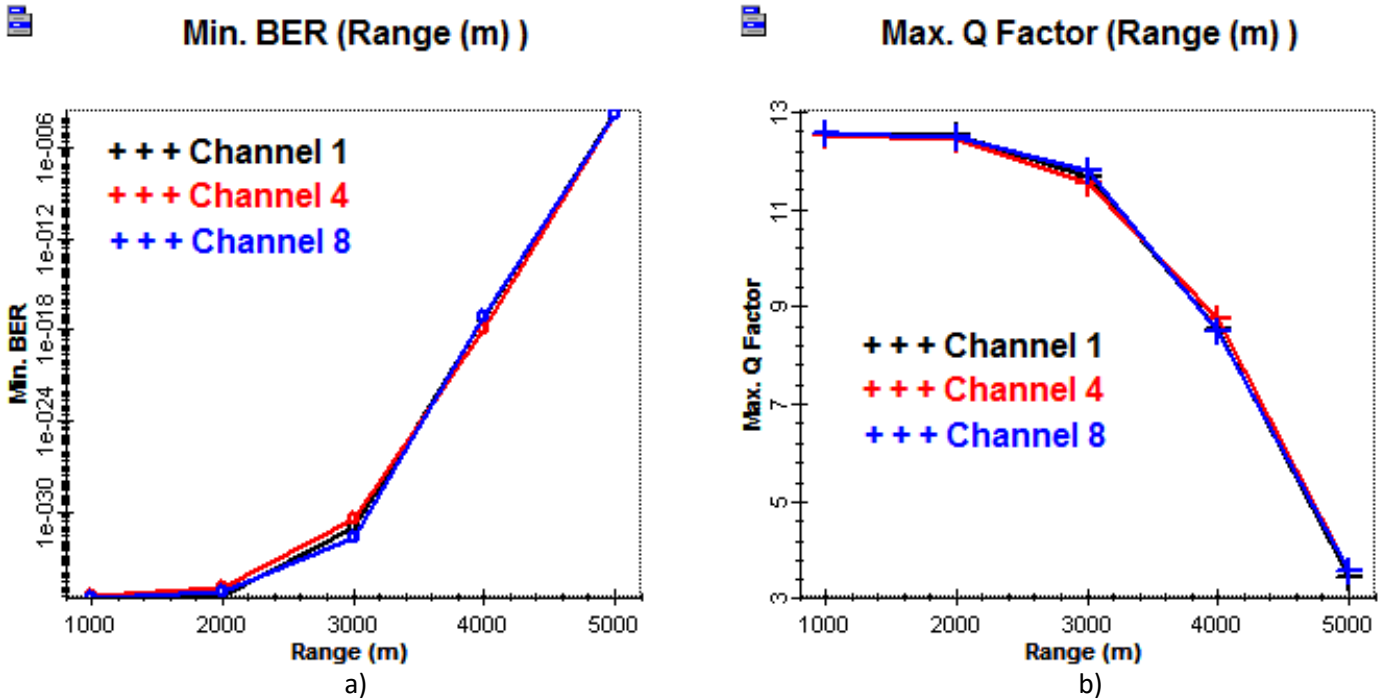

Figure 2: a) BER v/s FSO Range b) Q Factor v/s FSO Range.

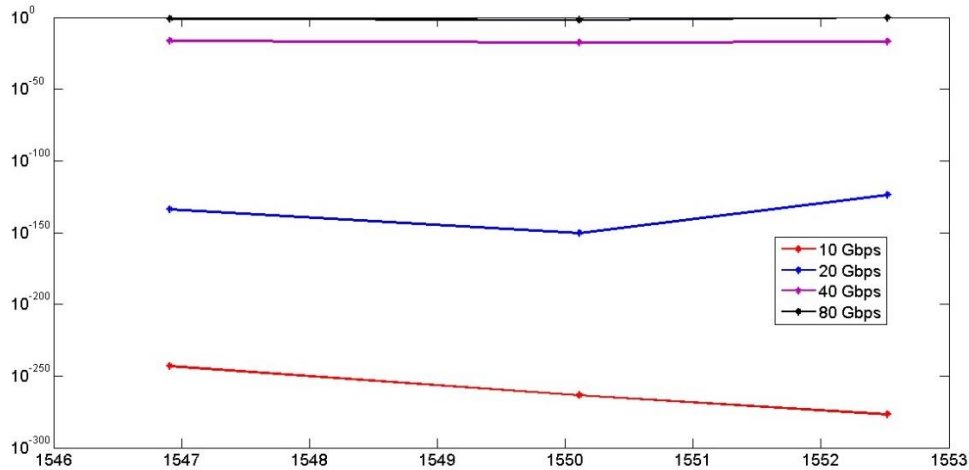

Figure 4: BER v/s Wavelength for different data bit rate.

The Q factor for each channel is degraded as FSO transmission link increases. Figure 4 represents BER for different data rate for various channels.

It is shown in Figure 4 that for data rate of 80 Gbps, the BER is 1 (very high) as compared to data rate of 10 Gbps, 20 Gbps, and 40 Gbps at FSO link of 4 Km. In other terms, BER increases as data rate for FSO transmission system increases. Figure 5(a) represents the curve of BER for channel 1, channel 4 and channel 8 with respect to input laser power. As the input power of laser increases, BER for each channel decreases. Similarly, Figure 5 (b) represents the quality factor of channel 1, channel 4 and channel 8 with respect to input laser power. It shows that quality factor of each channel increases as the input laser power increases.

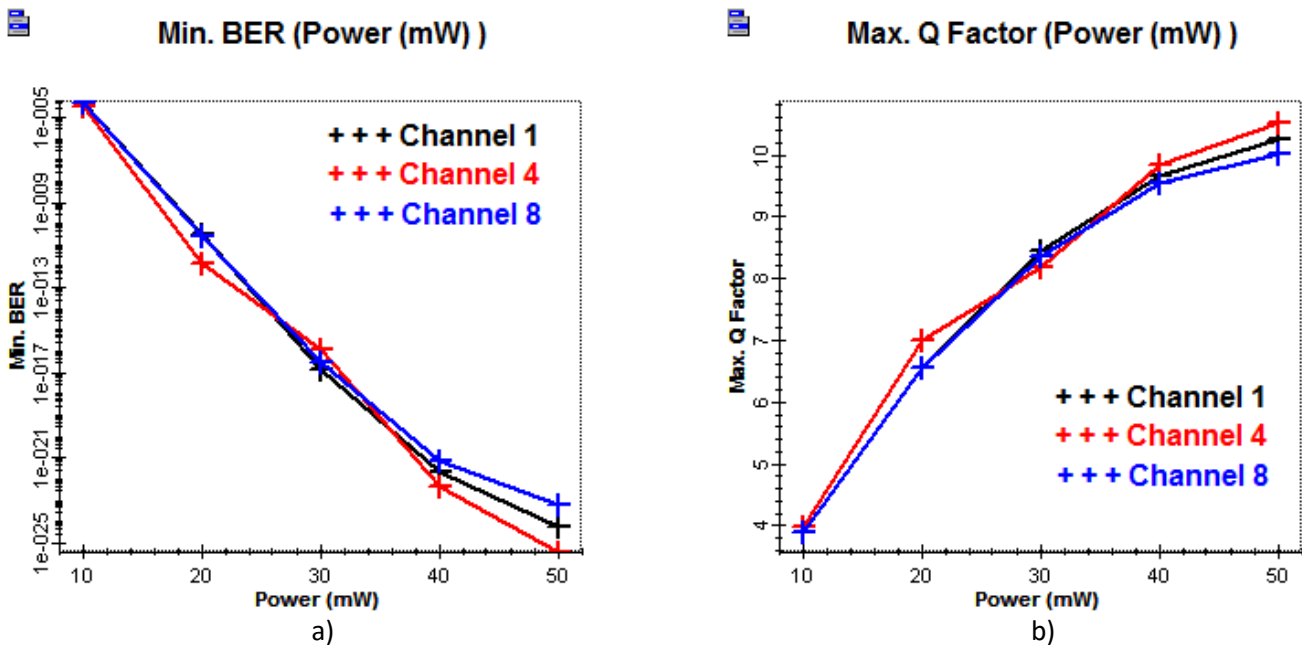

Figure 5: a) BER v/s Laser Power at FSO link of 4 Km (b) Q Factor v/s Laser Power at FSO link of 4 Km.



Figure 6 shows the measured BER for different attenuations of FSO link. It shows that as the attenuation of FSO link increases from 1 dB to 4 dB, the BER also increases. Figure 7 shows quality factor of channels with respect to different attenuation values. It shows that as the attenuation value increases, quality factor of all channels degraded. Figure 8 (a) represents BER of channel 1 v/s FSO range for different beam divergence values. It shows that as the divergence of beam increases, BER also increases. Similarly, Figure 8 (b) shows the quality factor of channel 1 v/s FSO range for different values of beam divergence. It shows that as the divergence of beam increases, Q factor of channel 1 is degraded.

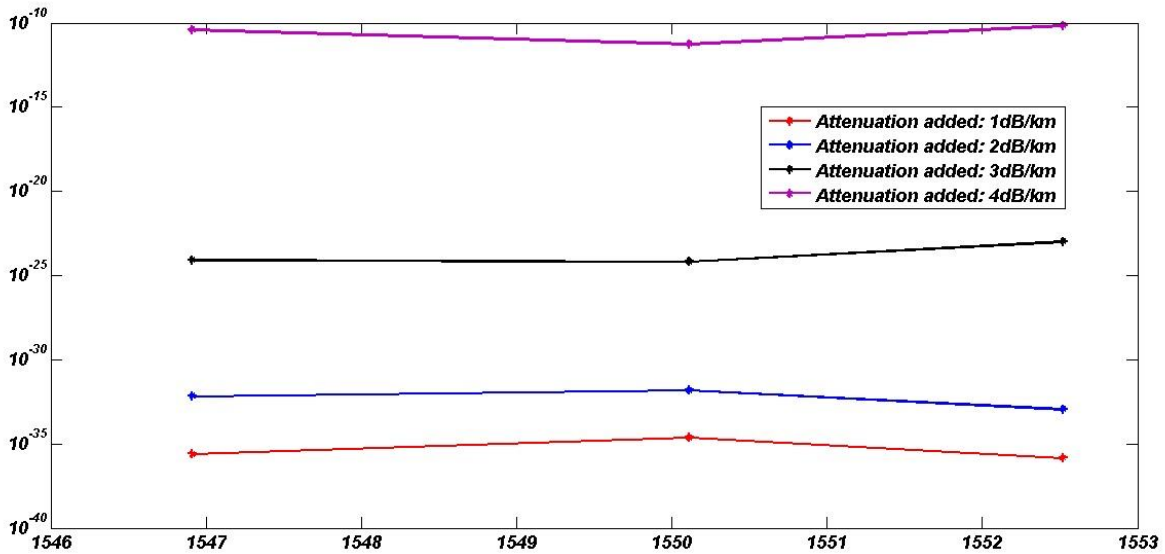

Figure 6: BER v/s wavelength for different FSO Attenuation

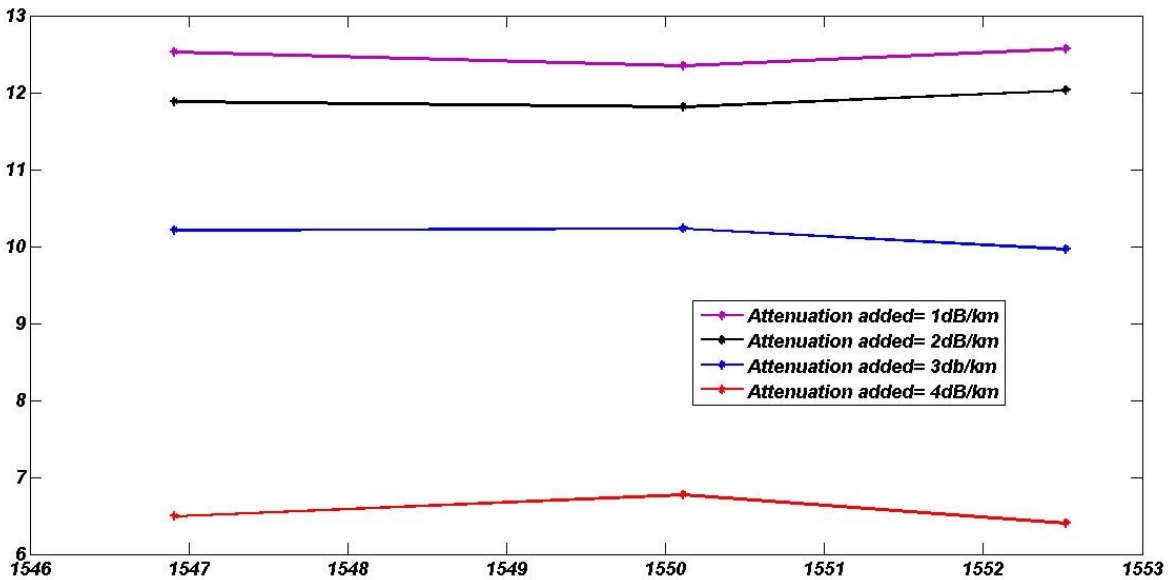
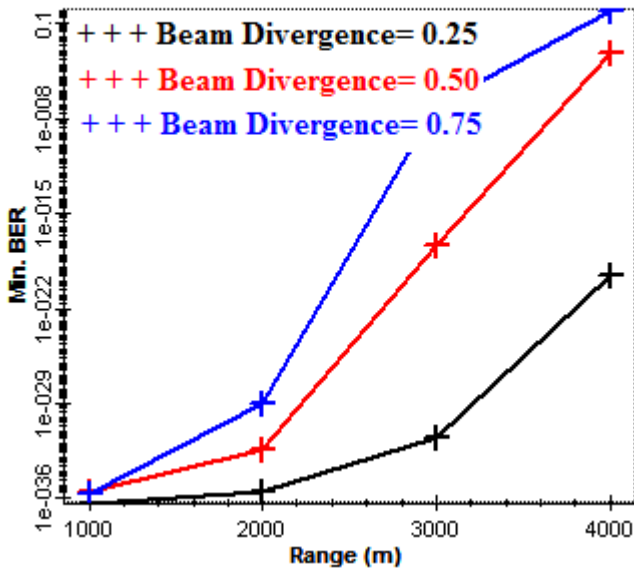

Figure 7: Q factor v/s wavelength for different FSO attenuations



### Min. BER (Range (m))



a)



### Max. Q Factor (Range (m))

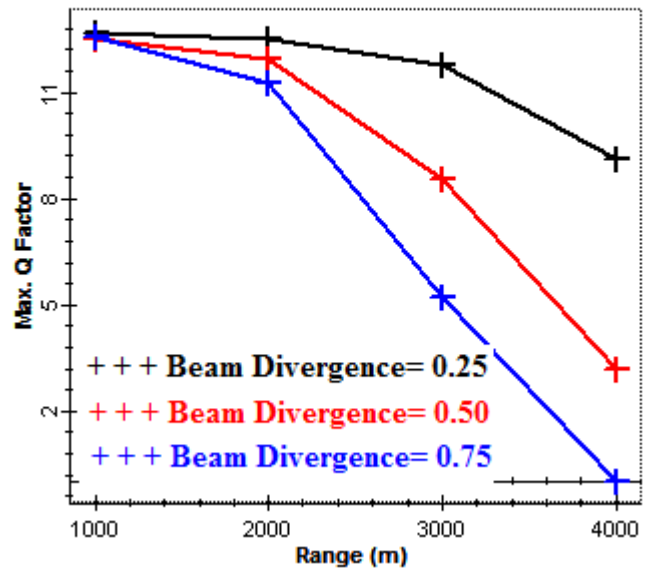

b)

Figure 8: a) BER v/s Range for different Beam divergence values b) Q Factor v/s Range for different Beam divergence values



### Min. BER (Receiver aperture diameter (cm))

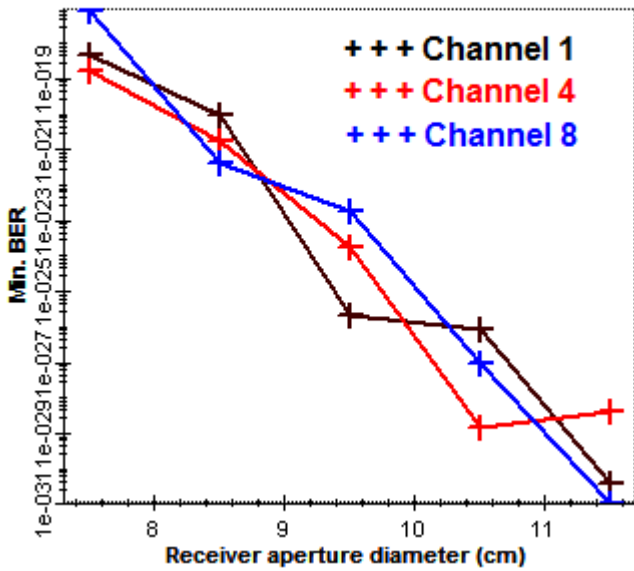

a)



### Max. Q Factor (Receiver aperture diameter (cm))

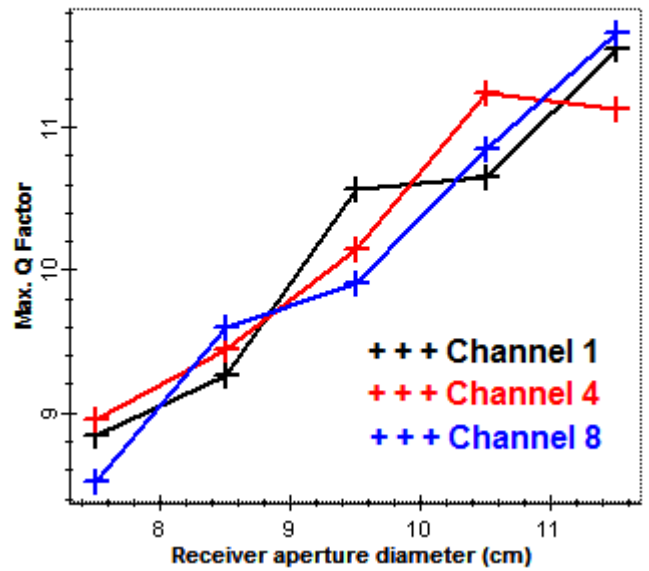

b)

Figure 9: a) BER v/s Receiver Aperture Diameter for channel 1, channel 4 and channel 8 b) Q factor v/s Receiver Aperture Diameter for channel 1, channel 4 and channel 8

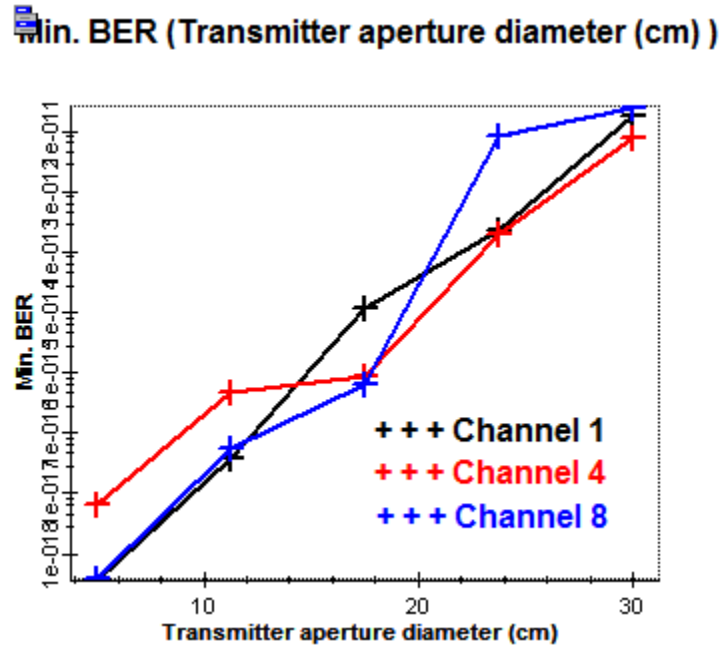

Figure 10: BER v/s Transmitter Aperture Diameter for channel 1, channel 4 and channel 8

Figure 9 (a) represents the curve of BER v/s FSO receiver aperture diameter for channel 1, channel 4 and channel 8 at FSO range of 4 Km. It shows that BER decreases as receiver aperture diameter of FSO increases. Similarly, it is shown in Figure 9 (b) that q factor of channel 1, channel 4 and channel 8 increases as the FSO receiver aperture diameter increases. Figure 10 represents the BER v/s transmitter aperture diameter for channel 1, channel 4 and channel 8 which show that BER increases as transmitter aperture diameter increases.

## Conclusion

In this work, we have designed equivalent 8 x 5Gbps DWDM-FSO system by using OptiSystem as mentioned in reference paper [1]. All the results from reference paper are reproduced/replotted by using OptiSystem software. However in reference paper, authors have not described all the parameters such as Photodiode noise bandwidth, thermal noise, Mach-Zehnder modulator extinction ratio, laser linewidth etc. We have optimised all those parameters which are not mentioned in reference paper in order to produce equivalent or closer results. Furthermore, the paper plots show a distinction between each channel, in some cases performing differently under the same settings, most notably channel 8. However, since none of the component models are wavelength dependent it is not clear where this discrepancy comes from.



**OptiSystem**

Optical Communication System  
and Amplifier Design Suite



## References

- [1] Parkash, Sooraj, et al. "Performance Investigation of 40 GB/s DWDM over Free Space Optical Communication System Using RZ Modulation Format." *Advances in Optical Technologies* 2016 (2016).